

# heatmiser®



Model: **Slimline-E**

Model: Slimline-E





# Table of Contents

Product Image	1
Table of Contents	2
What is a Programmable Room Thermostat?	3-4
Installation Procedure	5-6
LCD Display	7-8
Setting the Clock	9
Temperature Display	10
Setting the Comfort Levels	11-12
Locking the Thermostat	13
Temperature Control	14
Temperature Hold	15
Holiday Mode	16
Frost Protection	17
Heating On/Off	18
Optional Features Explained	19-22
Error Codes	23
Re-calibrating the Thermostat	24
Factory Reset	25
Wiring Diagram	26

## What is a Programmable Room Thermostat?

A programmable room thermostat is both a programmer and a room thermostat.

A programmer allows you to set “On” and “Off” periods to suit your own lifestyle. A room thermostat works by sensing the air temperature, switching on the heating when the air temperature falls below the thermostat setting, and switching it off once this set temperature has been reached.

So a programmable room thermostat lets you choose what times you want the heating to be on, and what temperature it should reach while it is on. It will allow you to select different temperatures in your home at different times of the day (and days of the week) to meet your particular needs and preferences.

Setting a programmable room thermostat to a higher temperature will not make the room heat up any faster. How quickly the room heats up depends on the design and size of the floor heating system.

Similarly reducing the temperature setting does not affect how quickly the room cools down. Setting a programmable room thermostat to a lower temperature will result in the room being controlled at a lower temperature, and saves energy.

The way to set and use your programmable room thermostat is to find the lowest temperature settings that you are comfortable with at the different times you have chosen, and then leave it alone to do its job.

The best way to do this is to set the room thermostat to a low temperature – say 18°C, and then turn it up by 1°C each day until you are comfortable with the temperature. You won't have to adjust the thermostat further. Any adjustment above this setting will waste energy and cost you more money.

You are able to temporarily adjust the heating program by overriding or using the temperature hold feature. These features are explained further on pages 14 and 15 of this manual.

Programmable room thermostats need a free flow of air to sense the temperature, so they must not be covered by curtains or blocked by furniture. Nearby electric fires, televisions, wall or table lamps may also prevent the thermostat from working properly.



## Installation Procedure



### Do

Mount the thermostat at eye level.

Read the instructions fully so you get the best from our product.



### Don't

Do not install near to a direct heat source as this will affect functionality. Do not push hard on the LCD screen as this may cause irreparable damage.

*This Slimline Series thermostat is designed to be flush mounted and requires a back box of 35mm (minimum depth) to be sunk into the wall prior to installation.*

### Step 1

Carefully separate the front half of the thermostat from the back plate by placing a small flat head terminal driver into the slots on the bottom face of the thermostat.

### Step 2

Place the thermostat front somewhere safe.

Terminate the thermostat as shown in the diagram on page 26 of this booklet.

### Step 3

Screw the thermostat back plate securely into the back box.

### Step 4

Clip the front of the thermostat back onto the thermostat back plate.

1



2



3

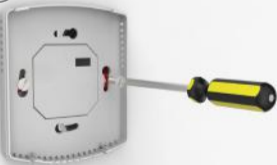

4



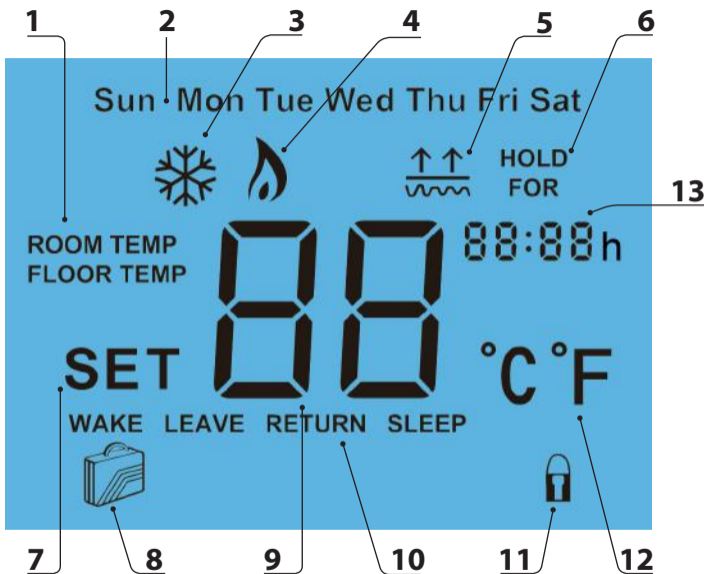









1. Room/Floor Temp - Indicates the current temperature sensor mode.
2. Day Indicator - Displays the current day.
3. Frost Icon - Displayed when the thermostat is in frost protection mode.
4. Flame Icon - Displayed when the thermostat is calling for heat, the flame icon will flash when the optimum start function is in operation.
5. Floor Temp Limit Icon - Displayed when the floor sensor probe has reached the temperature limit set on feature 09.
6. Temperature Hold - When a Temp Hold is active, HOLD FOR and the remaining time period is displayed.
7. Set - Indicates when changes are being made to programs or temperature set points.
8. Holiday Indicator - Displayed when the thermostat is in holiday mode.
9. Current Temp - Indicates the current sensor temperature.
10. Program Cycle Indicator - Displayed during programming only to show which period is being altered.
11. Keypad Lock Indicator - Displayed when the keypad is locked.
12. Units of Temperature - Degrees Celsius or Fahrenheit.
13. Clock - Digital clock display in 24h format.



## Setting the Clock

To set the clock, follow these steps.

- With the thermostat turned ON, press the Clock key twice ..... 
- Use the Up/Down keys to set the hours ..... 
- Press H to confirm settings ..... 
- Use the Up/Down keys to set the minutes ..... 
- Press H to confirm settings ..... 
- Use the Up/Down keys to set the day of the week ..... 
- Press A to confirm settings and return to main display ..... 

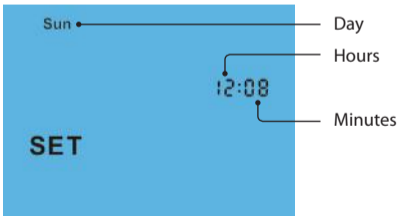

# Temperature Display

This thermostat can be setup to use an air sensor, floor sensor or both.

The display will clearly show which sensor is being controlled by showing either:

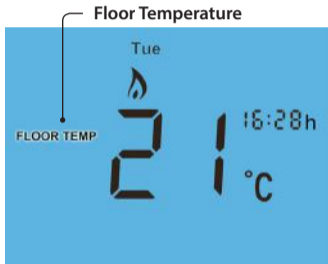
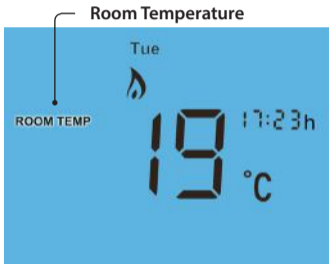

*Note: Built in air sensor only MUST NOT be used to control electric underfloor heating. Floor sensor only or built in air & floor sensor together must be used.*

When the thermostat is set to use both sensors, the room temperature will be displayed. To view the floor temperature, press and hold the  key until the Floor Temp is displayed on screen.



## Setting the Comfort Levels

The thermostat offers the following program mode options;

Non-Programmable – Basic up/down override temperature control.

5/2 Day Programming – 4 levels for the weekdays and 4 different levels for the weekend.

7 Day Programming – 4 levels for each day.

*Consult the 'Optional Features' section to select the required mode.*

- To program comfort levels, press Clock once .....









*For Weekday/Weekend programming,  
Mon Tue Wed Thu Fri  
are displayed on screen.*



*For 7 Day programming,  
only Mon is displayed  
in the day indicator field.*



## Setting the Comfort Levels Continued

- Use the Up/Down keys to enter the required WAKE time .....  
- Press H to confirm settings ..... 
- Use the Up/Down keys to enter the required WAKE temperature .....  
- Press H to confirm settings ..... 
- You will now see "LEAVE" displayed on screen.
- Repeat the programming steps for each period until complete.
- For unused periods enter --.-- and the thermostat will ignore the setting.
- Press A to confirm settings and return to main display ..... 



### Note:

- *In 7 Day programming mode you can repeat for each day independently.*
- *In Weekday/Weekend programming mode you will see Sat Sun displayed on screen and can repeat for the weekdays.*
- *To change the programming mode please refer to pages 19-22.*



## Locking the Thermostat

The thermostat has a keypad lock facility. To activate the lock follow these steps.

- Press and hold the A and Down keys together for 10 seconds .....  
- You will see the lock symbol appear on screen ..... 
- To unlock, repeat the steps above until the lock symbol disappears.

*Note: The keypad lock indicator is only displayed when the lock is active.*

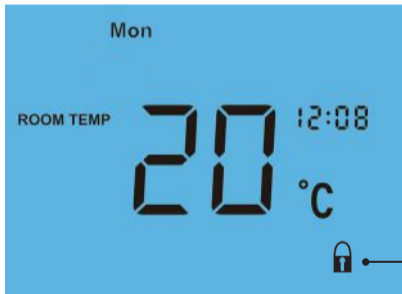

Keypad Lock Indicator



## Temperature Control

The Up/Down keys allow you to adjust the set temperature .....



When you press either key, you will see the word SET and the desired temperature will be displayed on screen.

Use the Up/Down keys to adjust the SET value .....



Press A to confirm settings and return to main display .....

*Note: In programmable mode, this new temperature is maintained only until the next programmed comfort level.*

*In non-programmable mode, this temperature will be constantly maintained.*

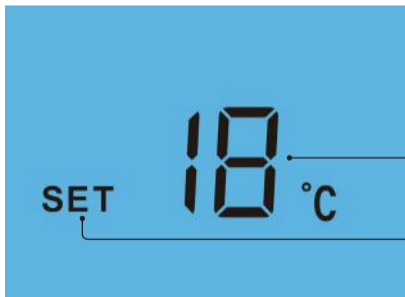

Set Temperature

Set Icon



## Temperature Hold

The temperature hold function allows you to manually override the current operating program and set a different temperature for a desired period.

- Press H to commence temperature hold .....
- Use the Up/Down keys to enter the required Hold time .....
- Press H to confirm settings .....
- Use the Up/Down keys to enter the required Hold temperature .....
- Press A to confirm settings and return to main display .....

You will see the HOLD FOR indication is displayed on screen.

The time will countdown the set duration and then revert to the normal program.

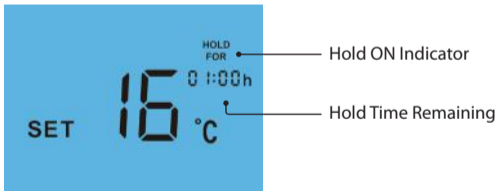

To cancel temperature hold, follow the same steps but reduce the hold time to 00:00.









## Holiday Mode

The holiday function reduces the set temperature in your home to the frost protection temperature setting (see page 22).

The thermostat will maintain this temperature for the duration of the holiday and will then automatically return to the program mode on your return.

- Press H three times (until you see the suitcase on screen) ..... 
- Use the Up/Down keys to enter the number of days holiday .....  
- Press A to confirm settings and return to main display ..... 

The display will show a suitcase indicating the thermostat is in holiday mode.

*Note: A holiday period does not start until 00:00 the next day. For example, if you set a holiday period on Friday for 2 days, Saturday will be counted as the first day and the thermostat will revert back to the programmed schedule at 00:00 on Monday.*



Holiday Days Holiday

ON Indicator

To cancel, follow the same steps but reduce the Holiday duration to 00 days.



## Frost Protection

Pressing the  button once will place the thermostat in frost protect mode.

In this mode, the thermostat will display the frost icon and will only turn the heating on should the room temperature drop below the set frost temperature (see page 19).

Should the heating be turned on whilst in frost protect mode, the flame icon will be displayed.

To cancel the frost protect mode, press the  button once again.



Frost Protect Mode Enabled



## Heating On/Off

The heating is indicated ON when the flame icon is displayed.

When the flame icon is absent, there is no requirement for heating to achieve the set temperature but the thermostat remains active.

To turn the thermostat OFF completely, press and hold the Power button.....



The display and heating output will be turned OFF completely.\*

To turn the thermostat back ON, press the Power button once again .....



Thermostat completely OFF



Thermostat powered ON



*\*See Feature 3 on page 19*



## Optional Features Explained

THE FOLLOWING SETTINGS ARE OPTIONAL AND IN MOST CASES NEED NOT BE ADJUSTED

**Feature 01 – Temperature Format:** This function allows you to select between °C and °F

**Feature 02 – Switching Differential:** This function allows you to increase the switching differential of the thermostat. The default is 1°C which means that with a set temperature of 20°C, the thermostat will switch the heating on at 19°C and off at 20°C. With a 2°C differential, the heating will switch on at 18°C and off at 20°C.

**Feature 03 – Frost Protect:** You can set whether the thermostat will maintain the frost temperature when the thermostat display is turned off. As a default, this is enabled.

**Feature 04 – Frost Protect Temperature:** This is the temperature maintained when the thermostat is in frost protect mode. The range is 07 - 17°C. The default is 12°C and is suitable for most applications.

**Feature 05 – Output Delay:** To prevent rapid switching, an output delay can be entered. This can be set from 00 - 15 minutes. The default is 00 which means there is no delay.

**Feature 06 – Communication Address:** Not in use on this model.

**Feature 07 – Temperature Up/Down Limit:** This function allows you to limit the use of the Up and Down keys. This limit is also applicable when the thermostat is locked and so allows you to give others limited control over the heating system.

**Feature 08 – Sensor Selection:** On this thermostat, you can select which sensor should be used. You can select between air temperature only, floor temperature, or both. When you enable both sensors, the floor sensor is used as a floor limiting sensor and is designed to prevent the floor from overheating.

*Note: Built in air sensor only MUST NOT be used to control electric underfloor heating. Floor sensor only or built in air & floor sensor together must be used.*

**Feature 09 – Floor Temp Limit:** When the Floor Sensor has been enabled in feature 08, you can set a floor limiting temperature between 20-45°C, this protects the floor from overheating.

(27°C is the default).

**Feature 10 – Optimum Start:** Optimum start will delay the start up of the heating system to the latest possible moment to avoid unnecessary heating and ensure the building is warm at the programmed time. The thermostat uses the rate of change information to calculate how long the heating needs to raise the building temperature 1°C (with a rate of change of 20, the thermostat has calculated the heating needs 20 minutes to raise the building temperature 1°C) and starts the heating accordingly.

On this thermostat, optimum start works on the Wake and Return comfort levels.

**Feature 11 – Rate of Change:** Number of minutes to raise the temperature by 1°C.

**Feature 12 – Programming Mode:** The following program modes are available;  
Non-Programmable – Basic up/down override temperature control.



5/2 Day Programming – 4 levels for the weekdays and 4 different levels for the weekend.

7 Day Programming – 4 levels for each day.





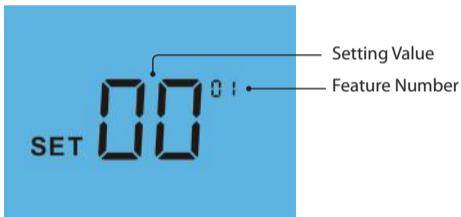

## Adjusting the Optional Settings

To adjust the optional settings, follow these steps.

- Press and hold the Power button to turn the thermostat OFF ..... 
- Press and hold the Clock key until the display appears as shown below ..... 



- Use the Clock key to cycle through the features ..... 
- Use the Up/Down keys to change the setting ..... 
- Press A to confirm settings ..... 
- Press the Power button once again to turn the thermostat back ON ..... 



## Optional Settings - Feature Table

FEATURE	DESCRIPTION	SETTING
01	Temperature Format	00 = °C, 01 = °F (°C = Default)
02	Switching Differential	01° - 03°C (01°C = Default)
03	Frost Mode	00 = Enabled, 01 = Disabled (00 = Default)
04	Frost Protection Temperature	07° - 17°C (12°C = Default)
05	Output Delay	00 - 15 Minutes (00 = Default)
06	Communications ID No.	Not in use on this model
07	Up/Down Temperature Limit	00° - 10°C (00 = Default)
08	Sensor Selection	00 = Built in Air Sensor 01 = Remote Air Sensor 02 = Floor Sensor Only 03 = Built In & Floor Sensor 04 = Remote Air & Floor Sensor
09	Floor Temperature Limit	20° - 45°C (27°C = Default)
10	Optimum Start	00 - 03 Hours (00 = Default)
11	Rate of Change	Minutes to raise by 1°C
12	Program Mode	00 = Non-Programmable 01 = 5/2 Day Programming 02 = 7 Day Programming



## Error Codes

**E0** = The internal sensor has developed a fault.  
You should contact your thermostat retailer for assistance.

**E1** = The remote floor probe has not been connected, has been wired incorrectly or the probe is faulty.

**E2** = The remote air probe has not been connected, has been wired incorrectly or the probe is faulty.







—● Error Number





## Re-calibrating the Thermostat

If you need to re-calibrate the thermostat, follow these steps.

- Press and hold the Power button to turn the thermostat OFF ..... 
- Press and hold BOTH the Power and Down keys together until the temperature appears on the screen ..... 
- Use the Up/Down keys to configure the new temperature ..... 
- Press A to confirm settings ..... 
- Press the Power button once to turn the thermostat back ON ..... 



Calibration Temperature Setting



Set Icon



## Factory Reset

The thermostat has a reset function to restore all settings to their factory defaults.

To perform a factory reset, follow these steps.

- Press and hold the Power button to turn the thermostat OFF ..... 
- Press and hold the Power and Up keys together until the LCD powers up.  
All of the icons will be displayed on screen ..... 
- When the icons have disappeared from the screen, the thermostat has been successfully reset.
- Press the Power button once to turn the thermostat back ON ..... 

All icons displayed simultaneously.



Factory reset is complete.





## Wiring Diagram - Slimline-E

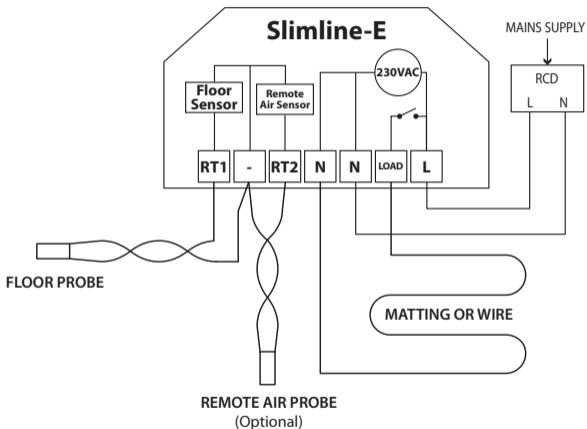



## Want More Information?

Call our support team on: +44 (0)1254 669090

Or view technical specifications directly on our website:  
[www.heatmiser.com](http://www.heatmiser.com)



PDF



FAQ



Video



Twitter: @heatmiseruk



Facebook: [facebook.com/thermostats](https://facebook.com/thermostats)